



LED MODULES

SA R-SP LED(2835) Series

Features

- High Efficiency 2835 LED Mounted
- Constant current (Non-DALI Compatible).
- 175° Wide beam angle optiLens applied.
- IP65 Rated
- Compact design and convenient usability.
- CE, ROHS and UL certified.
- 5Years Warranty

Specification

Item Code	Type	Power(W)	Luminous Flex(lm)	Current (A)	Max In Series
SA 9191	1 LED	1.0	95	0.083	60EA
SA 9291	2 LED	2.0	190	0.167	40EA
SA 9391	3 LED	3.0	285	0.25	20EA

Technical Characteristics

Voltage	DC12V
Efficiency	95lm/W
Viewing Angle	175°
IP Rating	IP65
CCT	6,500K
CRI(Ra)	80+
LED Type	2835 LED

Certification



Temperature Ranges

Operating temperature	-25~60°
Storage temperature	-25~70°

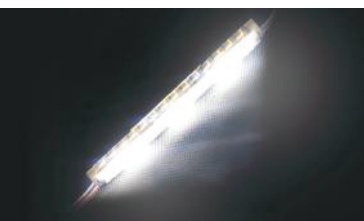

Warranty

Warranty	5 Years
----------	---------

Physical Characteristics

Profile Drawings

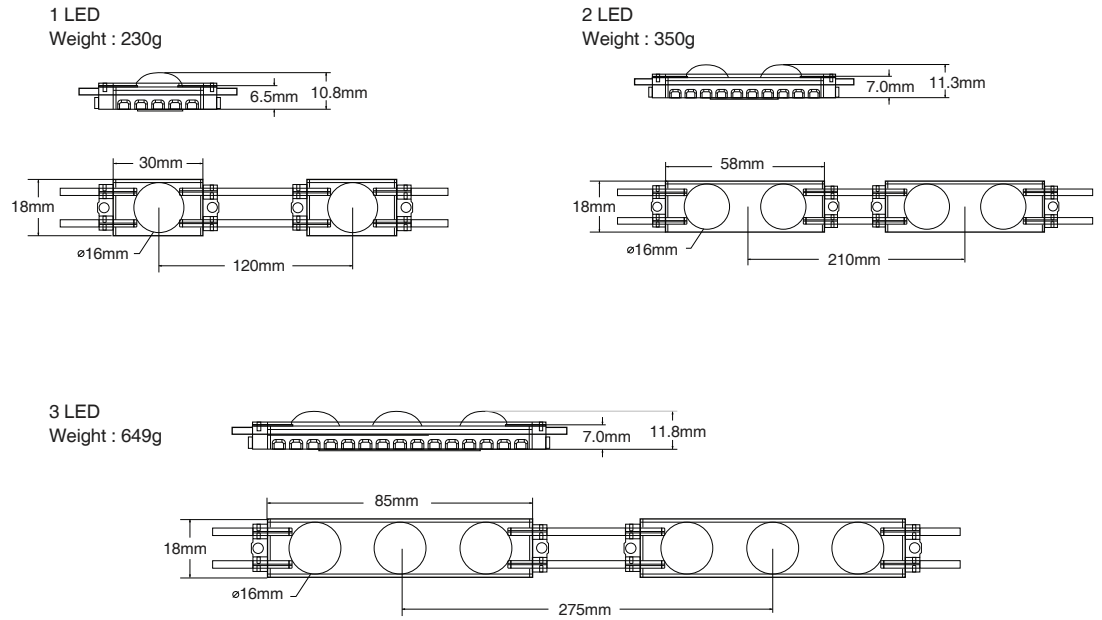

Module Layout Guides

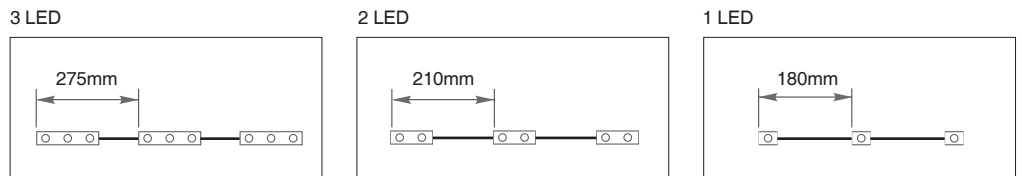

| Luminous intensity distribution diagram

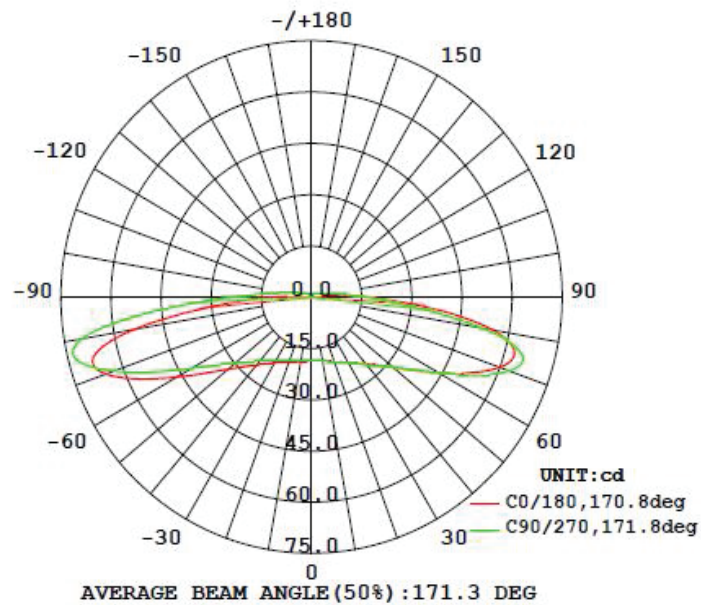

| 1LED - Max in series 60 EA

Single series ***Up-to 60 modules in a single series**



Multiple series ***Up-to 120 modules in max series**

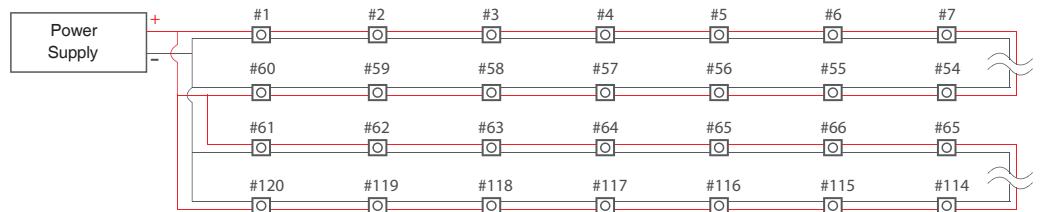

2LED - Max in series 40 EA

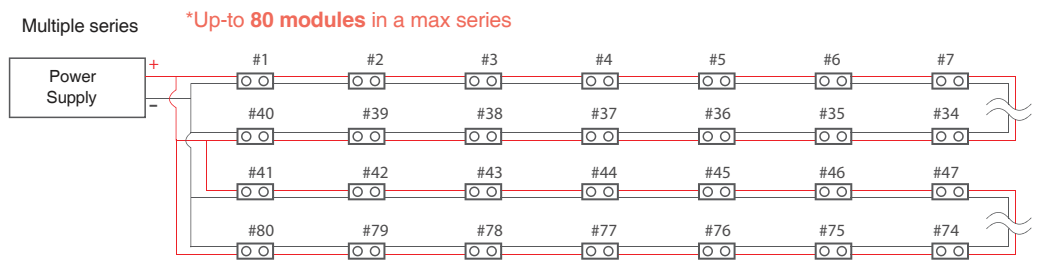
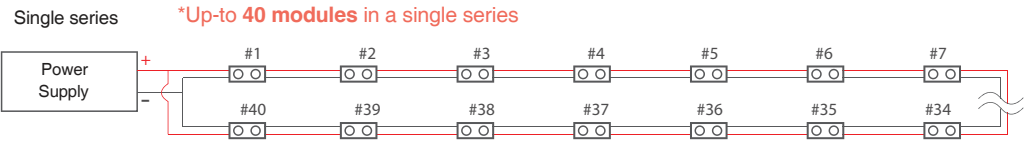

3LED - Max in series 20 EA

