

LED STRIP LIGHTING

WL COB RGB Strip

Features

- 7 Colour Available (R,G,B,Y,P,C,W) with RGB Controller
- Electronic dimming control supported
- 180° wide beam angle.
- Flexible with 3M back tape, easy for installation.
- 5 years warranty

Specification

Item Code	Emitting Colour	Luminous Flux(lm)	Efficiency(lm/W)	Viewing Angle
WL CUC5	Red	115	23	180°
	Green	325	65	180°
	Blue	75	15	180°

Technical Characteristics

Power Consumption	15W/M
Voltage	DC24V
Current Dissipation	0.625A
IP Rating	IP20
Cutable Length	50mm
Number of LED	840EA/M (4,200 LEDs)

Certification



IP Rating

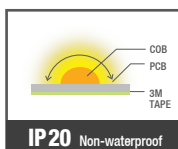

Temperature Ranges

Operating temperature	-20~40°
Storage temperature	-20~45°

Warranty

Warranty	5 years
----------	---------

Physical Characteristics

Dimensions : mm (W*H*M)	10 *1.6*5000
Weight	105g

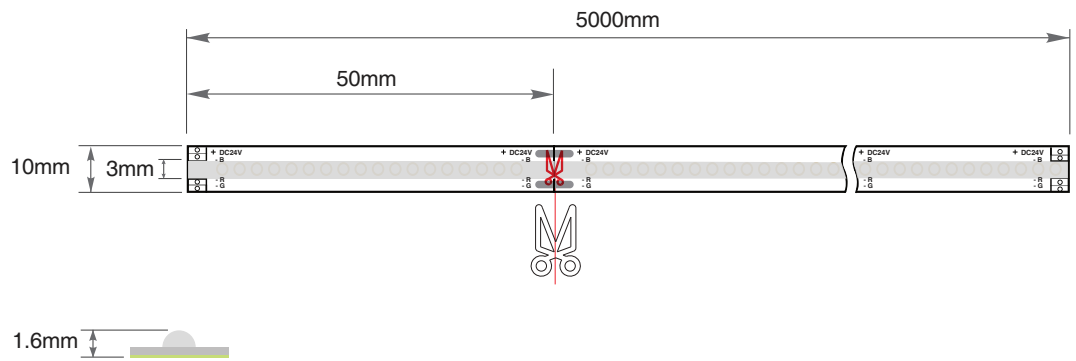

Max in series 5 Metre

